

0.4-mm Pitch Board to FPC Connector

XB4A/XB4B

Ultra-low profile connector with a stacking height of 0.9 mm and high contact reliability.

- Provides a firm tactile “click” and a high removal force.
- Twist-resistant design allows removal in all directions.
- Easy insertion through self-alignment.
- Double contacts ensure highly reliable contact.
- Halogen Free (See note)

Note: OMRON uses the following standard to determine halogen-free construction: 900 ppm max. for Br, 900 ppm max. for Cl, and 1,500 ppm max. for Br+Cl.

- RoHS Compliant

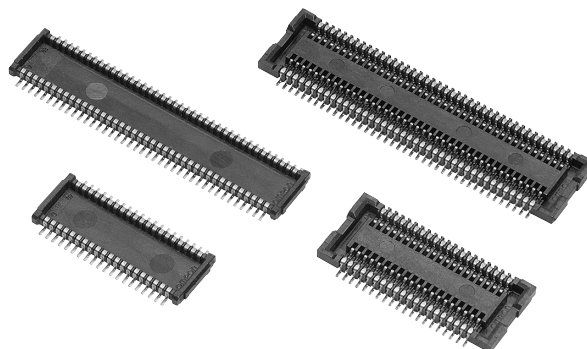

Ordering Information

Type	Pin No.	Model	Quantity per reel (See Note)
Plug	24	XB4A-2435-D	3,000
	40	XB4A-4035-D	
	50	XB4A-5035-D	
	60	XB4A-6035-D	
	80	XB4A-8035-D	
Socket	24	XB4B-2435-D	3,000
	40	XB4B-4035-D	
	50	XB4B-5035-D	
	60	XB4B-6035-D	
	80	XB4B-8035-D	

Note: Please order a multiple of the quantity per reel.

Ratings and Specifications

■ Characteristics

Rated Current	0.3 A AC/DC
Rated Voltage	50 V AC/DC
Contact resistance	60 mΩ max. (at 20 mV DC max., 100 mA max.)
Insulation resistance	100 MΩ min. (at 250 VDC)
Withstand voltage	250 VAC for 1 min. (leakage current: 1 mA max.)
Total insertion force	Pin number x 1.7N max.
Total removal force	Pin number x 0.1N min.
Insertion tolerance	50 times
Ambient operating temperature	-30 to 85°C (with no icing at low temperatures.)

■ Material and Finish

Housing	LCP resin (UL94-0)/black
Contacts	Spring copper alloy/nickel substrate (2 μm) Gold-plated contacts (0.15 μm)

Dimensions

■ XB4A Plug, SMT terminal

XB4A-□□35-D

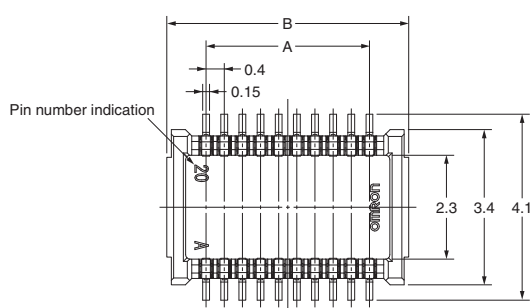

PCB Mating Dimensions (TOP VIEW)

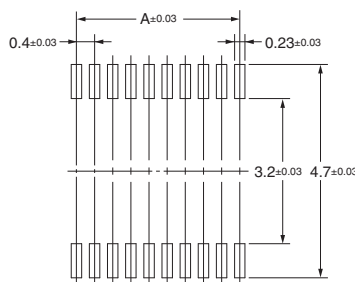

Pin No.	Model	A	B
24	XB4A-2435-D	4.4	6.1
40	XB4A-4035-D	7.6	9.3
50	XB4A-5035-D	9.6	11.3
60	XB4A-6035-D	11.6	13.3
80	XB4A-8035-D	15.6	17.3

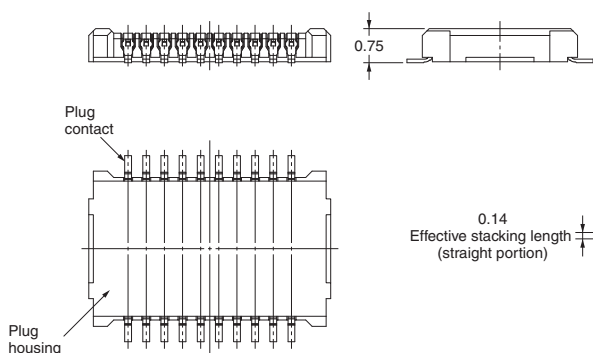

Stacking state
(Stacking connector is XB4B.)

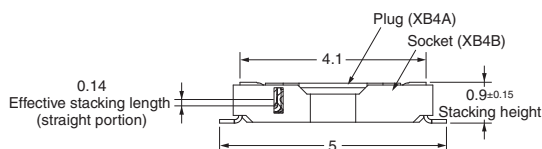

■ XB4B Socket, SMT terminal

XB4B-□□35-D

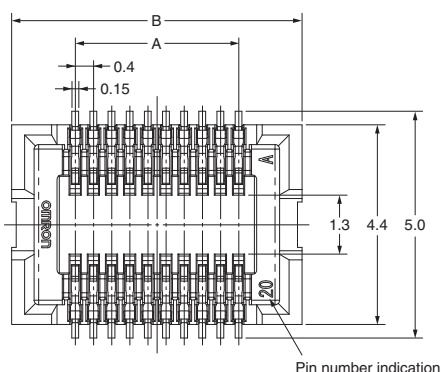

PCB Mating Dimensions (TOP VIEW)

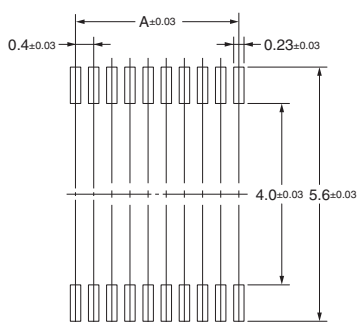

Pin No.	Model	A	B
24	XB4B-2435-D	4.4	7.2
40	XB4B-4035-D	7.6	10.4
50	XB4B-5035-D	9.6	12.4
60	XB4B-6035-D	11.6	14.4
80	XB4B-8035-D	15.6	18.4

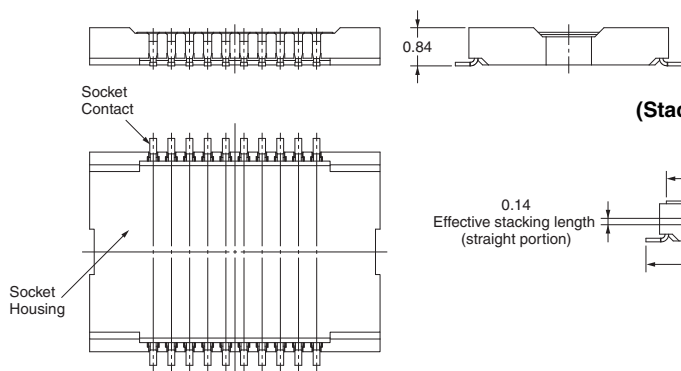

Stacking state
(Stacking connector is XB4A.)

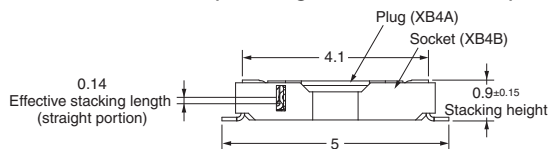

Safety Precautions

Precautions for Correct Use

For Operating

- Regarding the connector stacking operation, it should be confirmed there is no extreme displacement and tilt in the stacking contact areas between a plug and a socket before the stacking operation of the connectors.
- Ensure that the connector stackings are fully seated.
 - An incomplete stacking state may cause the failure of contact reliability.
- Do not apply an extreme load when inserting or drawing out the connector.
 - The connector may be damaged, resulting in faulty contacts.
- When stacking the plug and socket, press the back side of printed circuit board mounted with them and then couple with as little twisting force as possible.
 - Doing so may cause the terminal and housing to change shape or the housing to crack.

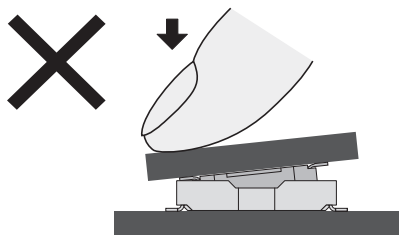
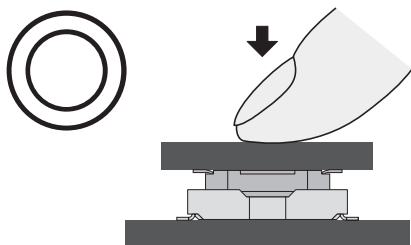

- When drawing out, hold the edge of the printed circuit board near the connector and remove as vertically as possible, as described in the figure below.
 - Drawing out the plug with too much force may have possibility to change shape of terminal solder/housing crack.

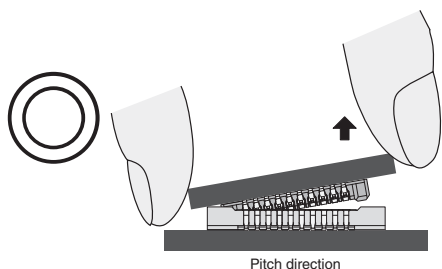
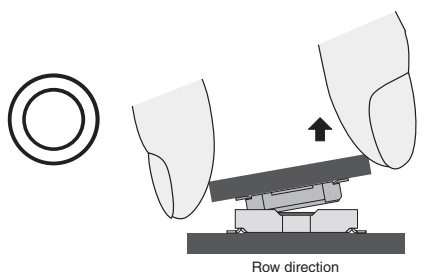

- Do not insert a foreign object such as a tweezers into the connector stacking contact area.
 - Doing so may cause the plating peel off and deform the shape of the terminal.

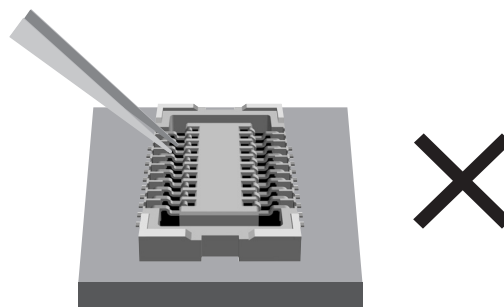

For Mounting

- The reflow conditions are as stated in OMRON's specifications and guidelines. These conditions, however, depend on the type of solder, the manufacturer, the amount of solder, the size of the circuit board, and the other mounting materials.
- When mounting the connector by manual soldering, observe the following precautions to ensure contact reliability.
 - Conditions for manual soldering: $350 \pm 10^\circ\text{C}$ 3 ± 1 sec
 - Do not apply an excessive amount of solder. Excessive solder will cause the flux creep.
 - Do not apply the soldering iron to the mounting terminal. Doing so may cause the connectors to change shape.
 - Do not apply the soldering iron to any parts of the connector other than the mount attachments. Doing so may cause the connector to change shape.

For Designing

- When mounting the connector to the FPC, design the FPC so that extreme peel force should not be applied directly on to the connector. If the FPC bends near the connector, or if the FPC is used with extreme peel force directly on to the connector, it may cause a contact loss.
- If the connector-mounted FPC is installed at a location or in any equipment that will subject the FPC to continuous shake or movement, secure the FPC or take any countermeasure against FPC disconnection from the connector.
- Do not use plural connectors on same PCB.
 - Doing so may cause solder and housing crack.
- When locating the connector on the printed circuit board, be sure to allow space for the stacking operation.
- Ensure a metal mask thickness of $t = 0.10$ to 0.15 mm. The recommended open area of the metal mask is 90% of the printed circuit board's mating dimensions as shown in the dimensional diagrams.

Name of the Parts for Board to Board Connectors

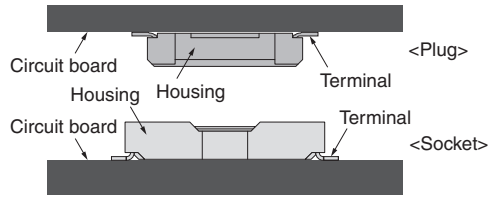

Handling Methods

How to couple a connector

1. Position a plug with a socket.

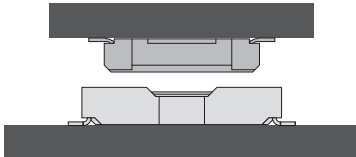

2. Insert the connector until it becomes horizontal.



How to draw out the connector

1. Hold the edge of the printed circuit board near the connector and draw out as vertically as possible.

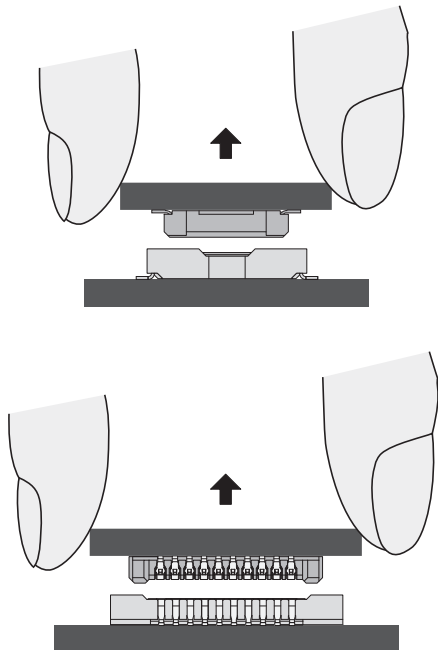

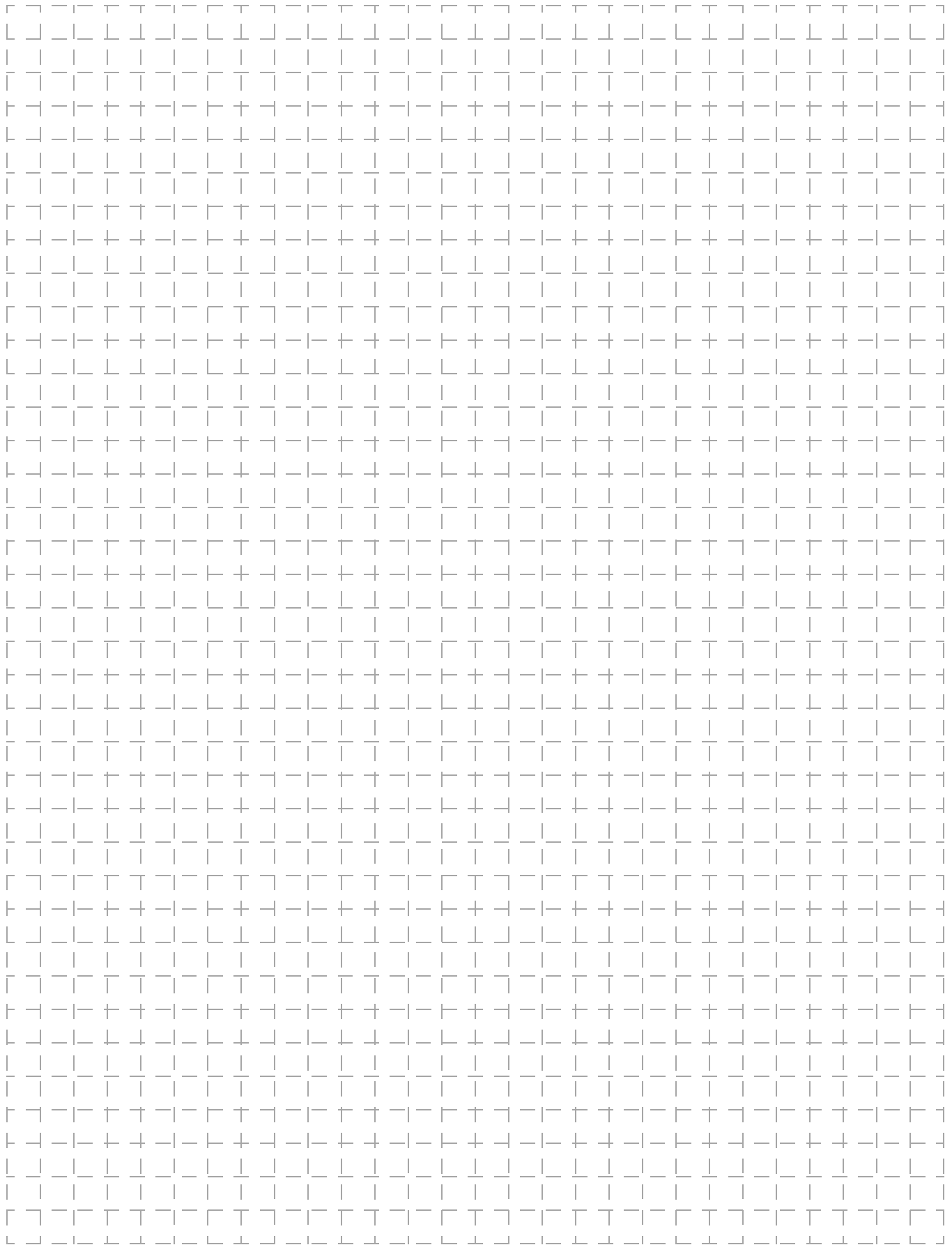

All sales are subject to Omron Electronic Components LLC standard terms and conditions of sale, which can be found at http://www.components.omron.com/components/web/webfiles.nsf/sales_terms.html

ALL DIMENSIONS SHOWN ARE IN MILLIMETERS.
To convert millimeters into inches, multiply by 0.03937. To convert grams into ounces, multiply by 0.03527.

OMRON[®]

**OMRON ELECTRONIC
COMPONENTS LLC**

55 E. Commerce Drive, Suite B
Schaumburg, IL 60173

847-882-2288

OMRON ON-LINE

Global - <http://www.omron.com>

USA - <http://www.components.omron.com>

Cat. No. X304-E-1b

02/13

Specifications subject to change without notice

Printed in USA